

Poles available in the following heights:
10 ft. - 12 ft. - 13 ft.

(4" Square Pole
with Street Sign Mount)

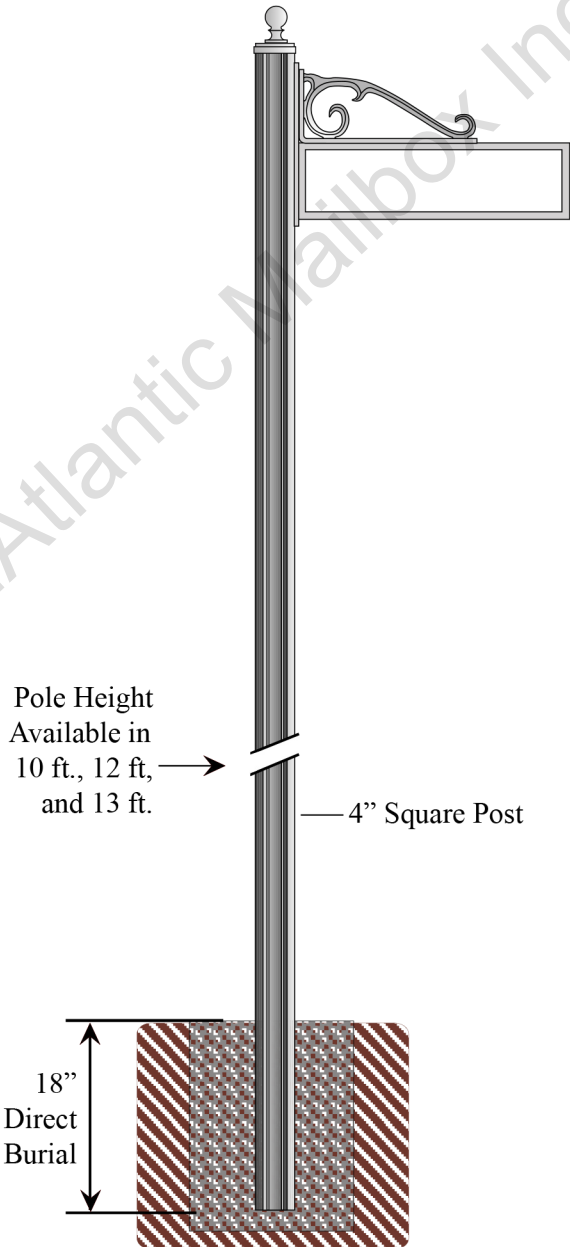

MP-7** Fluted Post

- 4" Square Fluted Post
- Made of Extruded Aluminum
- .0188 Wall Thickness
- Direct Burial

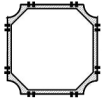

TSB-202 - Single Street Sign Mount

- Mounts to any square pole
- Can be ordered to hold any size sign blade
- Made of Extruded Aluminum
- (See Traffic Pole Accessories Section for product specifications)

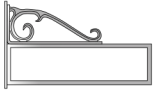

TSB11 - Post Topper

- Decorative Post Topper that fits 4" square posts.
- Made of Cast Aluminum.
- 4 1/4" wide x 5 1/4" tall



Additional Post
Topper Options:



TSB12

Finish

- The fixture will be finished with a premium quality thermoset polyester powdercoat for a durable finish.

Installation Instructions for Direct Burial Posts:

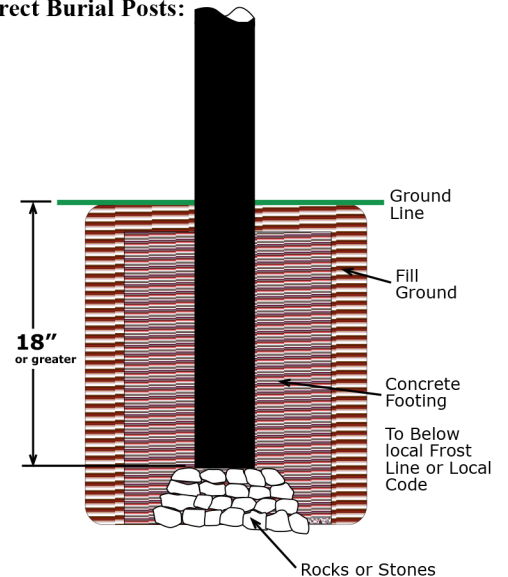

Poles available in the following heights:

10 ft. - 12 ft. - 13 ft.

(4" Square Pole
with Street Sign Mount
and Stop Sign Frame)

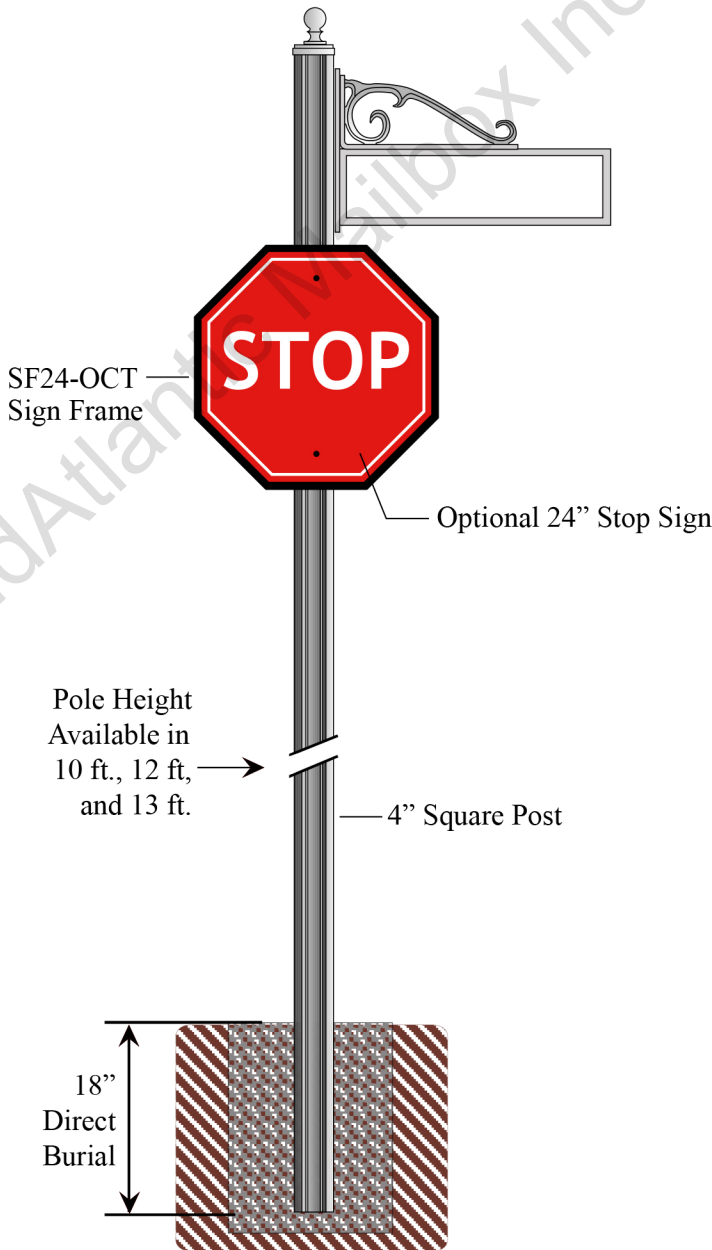

MP-7 Fluted Post**

- 4" Square Fluted Post
- Made of Extruded Aluminum
- .0188 Wall Thickness
- Direct Burial

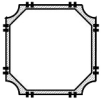

TSB-202 - Single Street Sign Mount

- Mounts to any square pole
- Can be ordered to hold any size sign blade
- Made of Extruded Aluminum
- (See Traffic Pole Accessories Section for product specifications)

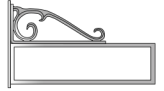

TSB11 - Post Topper

- Decorative Post Topper that fits 4" square posts.
- Made of Cast Aluminum.
- 4 1/4" wide x 5 1/4" tall



Additional Post
Topper Options:



TSB12

SF24-OCT Sign Frame

- Fits around 24" Stop Sign
- Has a 1" square edge on all sides
- Made of Cast Aluminum

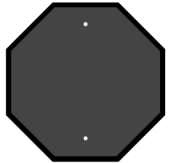

Finish

- The fixture will be finished with a premium quality thermoset polyester powdercoat for a durable finish.

**Installation Instructions
for Direct Burial Posts:**

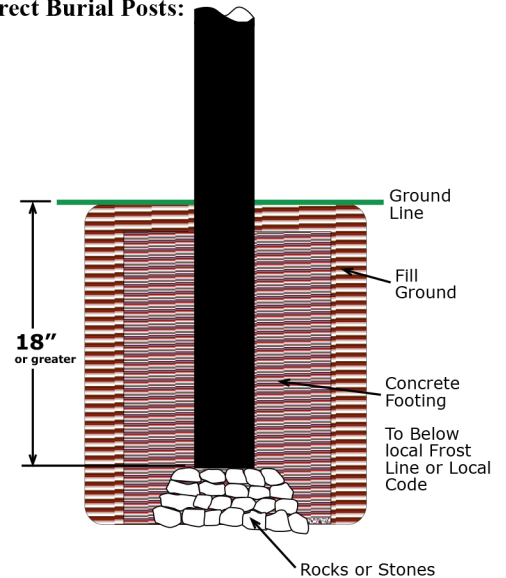

Poles available in the following heights:
10 ft. - 12 ft. - 13 ft.

(4" Square Pole
with Street Sign Mount)

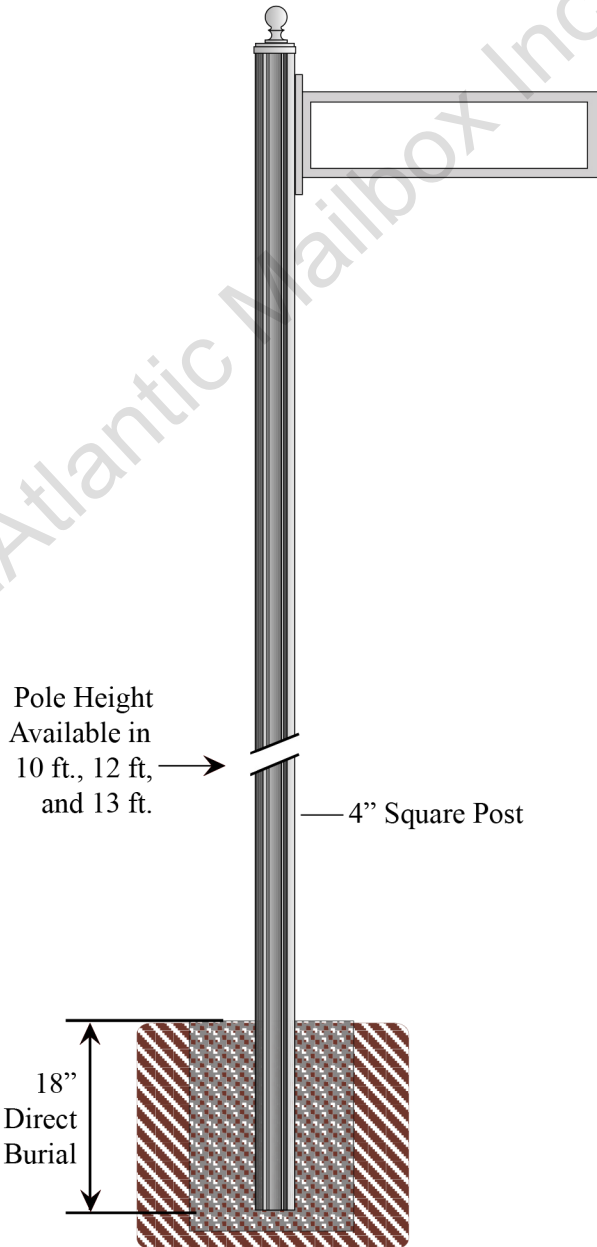

MP-7** Fluted Post

- 4" Square Fluted Post
- Made of Extruded Aluminum
- .0188 Wall Thickness
- Direct Burial

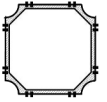

TSB-203 - Single Street Sign Mount

- Mounts to any square pole
- Can be ordered to hold any size sign blade
- Made of Extruded Aluminum
- (See Traffic Pole Accessories Section for product specifications)



TSB11 - Post Topper

- Decorative Post Topper that fits 4" square posts.
- Made of Cast Aluminum.
- 4 1/4" wide x 5 1/4" tall



Additional Post
Topper Options:



TSB12

Finish

- The fixture will be finished with a premium quality thermoset polyester powdercoat for a durable finish.

Installation Instructions for Direct Burial Posts:

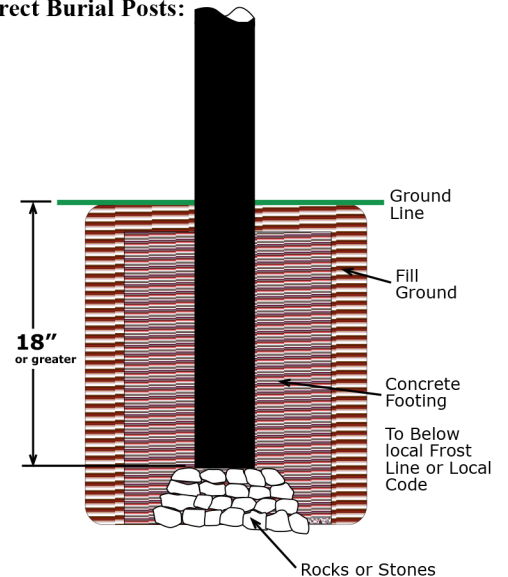

Poles available in the following heights:

10 ft. - 12 ft. - 13 ft.

(4" Square Pole
with Street Sign Mount
and Stop Sign Frame)

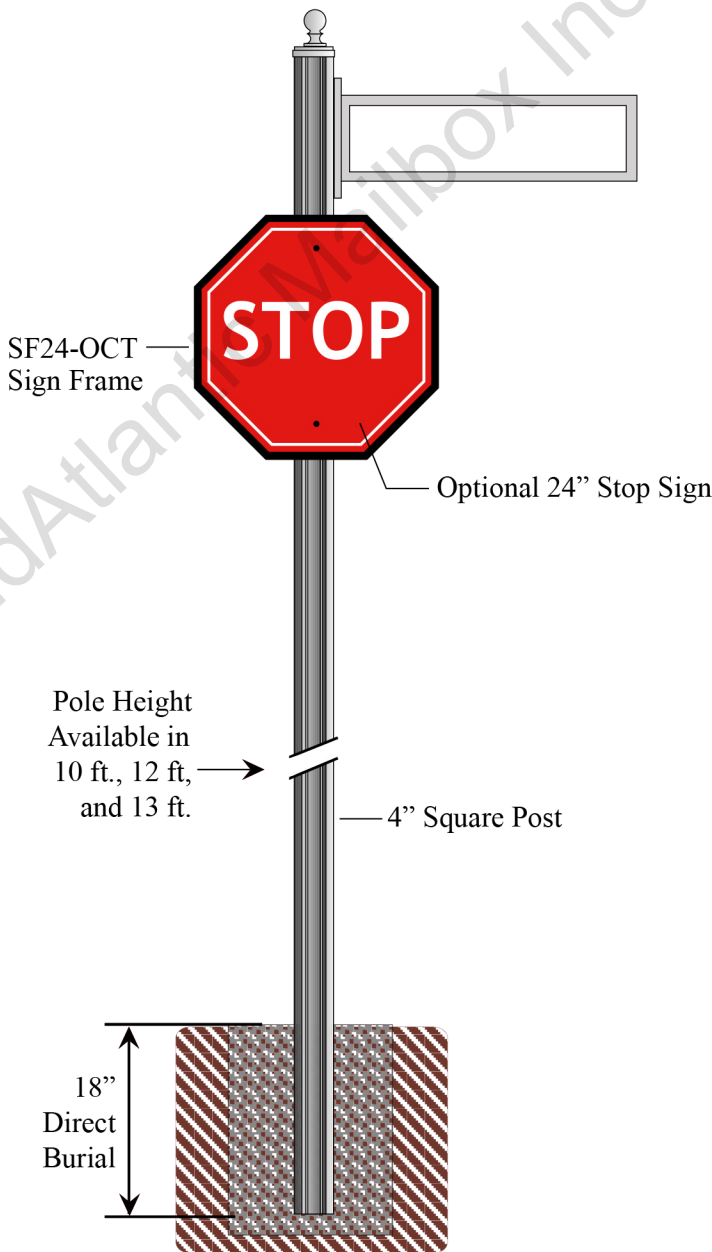

MP-7 Fluted Post**

- 4" Square Fluted Post
- Made of Extruded Aluminum
- .0188 Wall Thickness
- Direct Burial

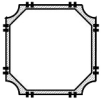

TSB-203 - Single Street Sign Mount

- Mounts to any square pole
- Can be ordered to hold any size sign blade
- Made of Extruded Aluminum
- (See Traffic Pole Accessories Section for product specifications)



TSB11 - Post Topper

- Decorative Post Topper that fits 4" square posts.
- Made of Cast Aluminum.
- 4 1/4" wide x 5 1/4" tall



Additional Post
Topper Options:



TSB12

SF24-OCT Sign Frame

- Fits around 24" Stop Sign
- Has a 1" square edge on all sides
- Made of Cast Aluminum

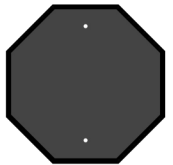

Finish

- The fixture will be finished with a premium quality thermoset polyester powdercoat for a durable finish.

**Installation Instructions
for Direct Burial Posts:**

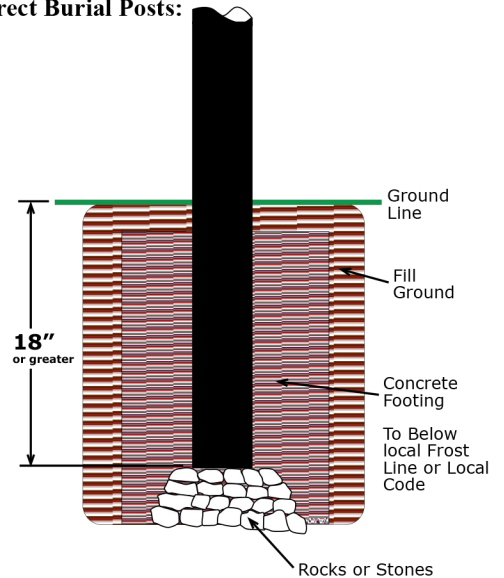

Poles available in the following heights:
10 ft. - 12 ft. - 13 ft.

**(4" Square Pole
with Street Sign Mount)**

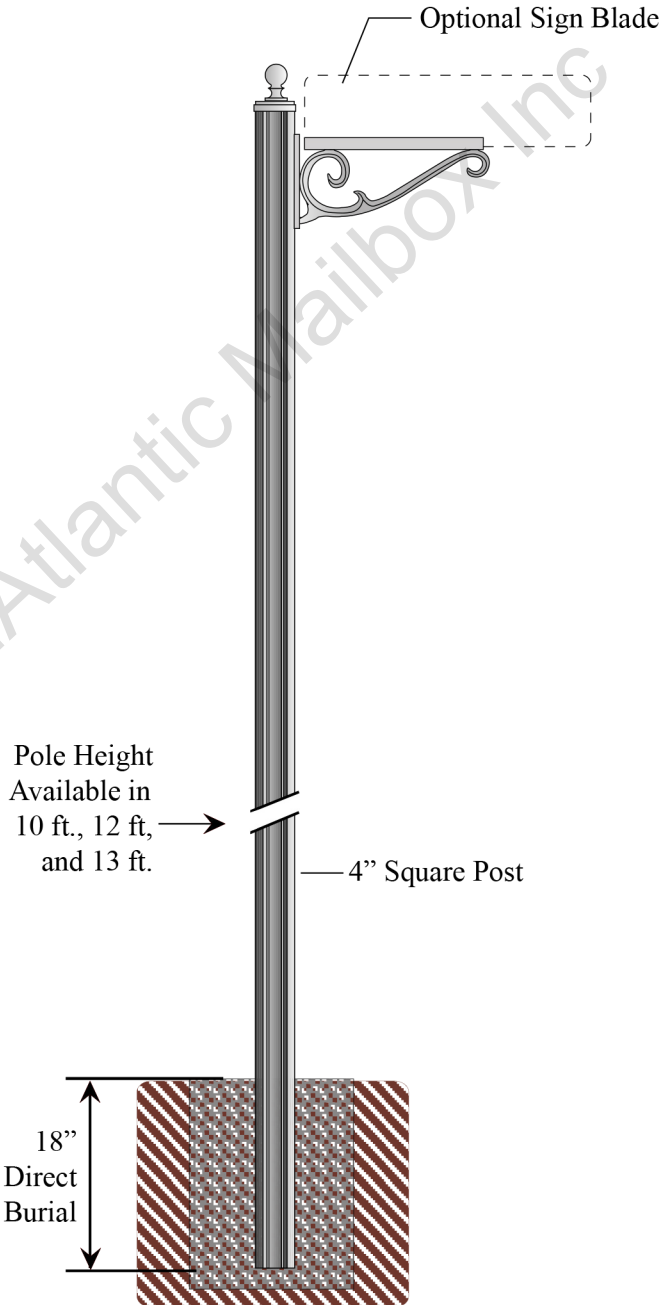

MP-7 Fluted Post**

- 4" Square Fluted Post
- Made of Extruded Aluminum
- .0188 Wall Thickness
- Direct Burial

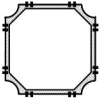

TSCR-700 - Single Street Sign Mount

- Mounts to any square pole
- Can be ordered to hold any size sign blade
- Made of Extruded Aluminum
- (See Traffic Pole Accessories Section for product specifications)*

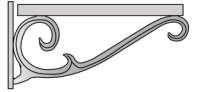

TSB11 - Post Topper

- Decorative Post Topper that fits 4" square posts.
- Made of Cast Aluminum.
- 4 1/4" wide x 5 1/4" tall



Additional Post Topper Options:



TSB12

Finish

- The fixture will be finished with a premium quality thermoset polyester powdercoat for a durable finish.

Installation Instructions for Direct Burial Posts:

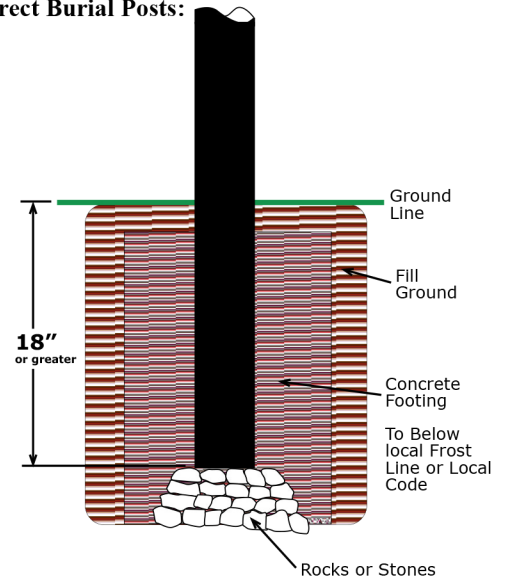

Poles available in the following heights:

10 ft. - 12 ft. - 13 ft.

(4" Square Pole
with Street Sign Mount
and Stop Sign Frame)

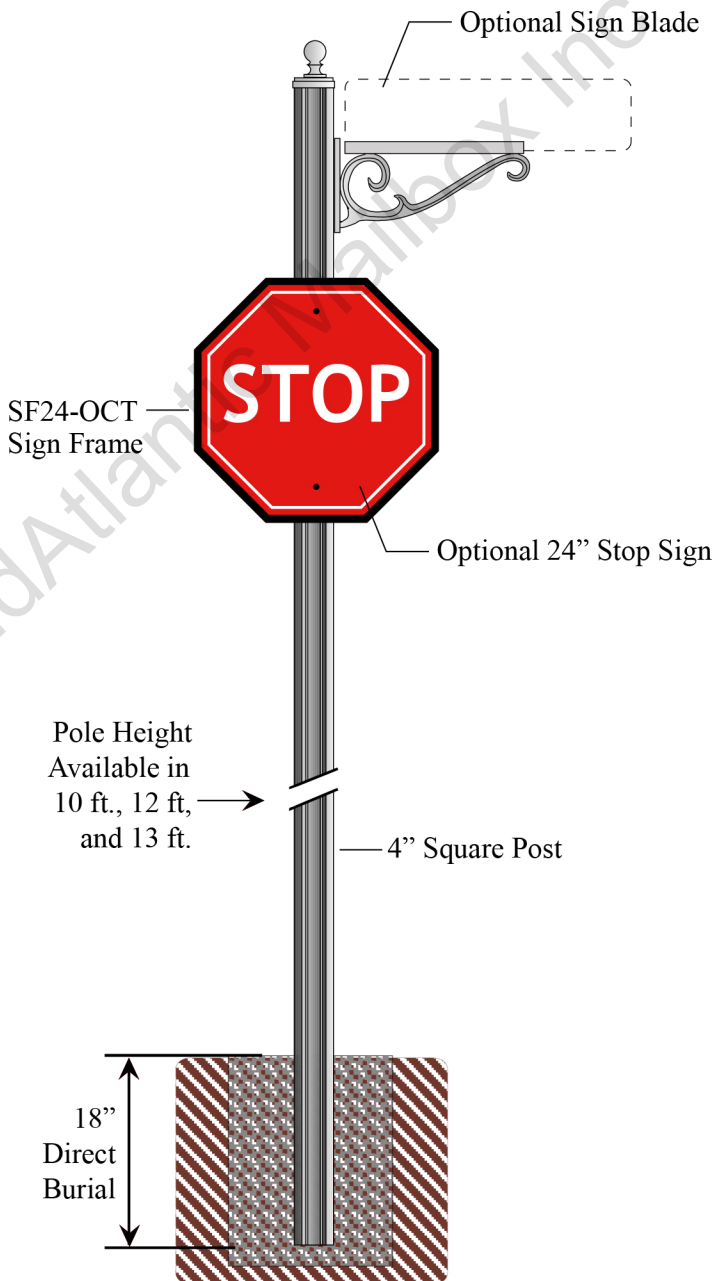

MP-7 Fluted Post**

- 4" Square Fluted Post
- Made of Extruded Aluminum
- .0188 Wall Thickness
- Direct Burial

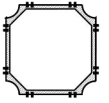

TSCR-700 - Single Street Sign Mount

- Mounts to any square pole
- Can be ordered to hold any size sign blade
- Made of Extruded Aluminum
- (See Traffic Pole Accessories Section for product specifications)

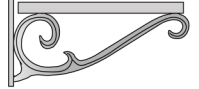

TSB11 - Post Topper

- Decorative Post Topper that fits 4" square posts.
- Made of Cast Aluminum.
- 4 1/4" wide x 5 1/4" tall



Additional Post
Topper Options:



TSB12

SF24-OCT Sign Frame

- Fits around 24" Stop Sign
- Has a 1" square edge on all sides
- Made of Cast Aluminum

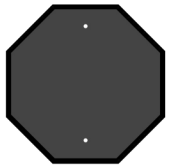

Finish

- The fixture will be finished with a premium quality thermoset polyester powdercoat for a durable finish.

**Installation Instructions
for Direct Burial Posts:**

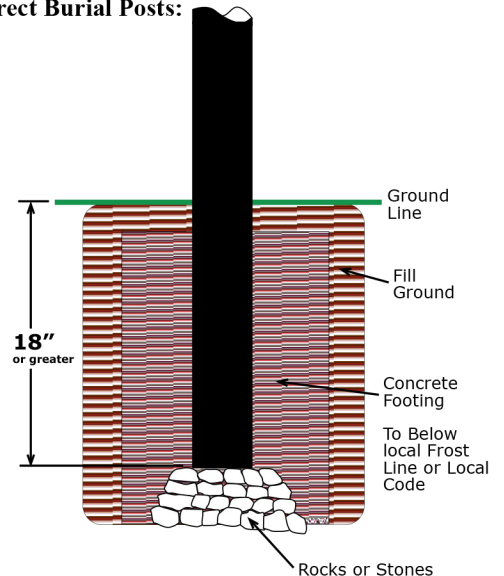

Poles available in the following heights:
10 ft. - 12 ft. - 13 ft.

(4" Square Pole with Street Sign Mount and Base)

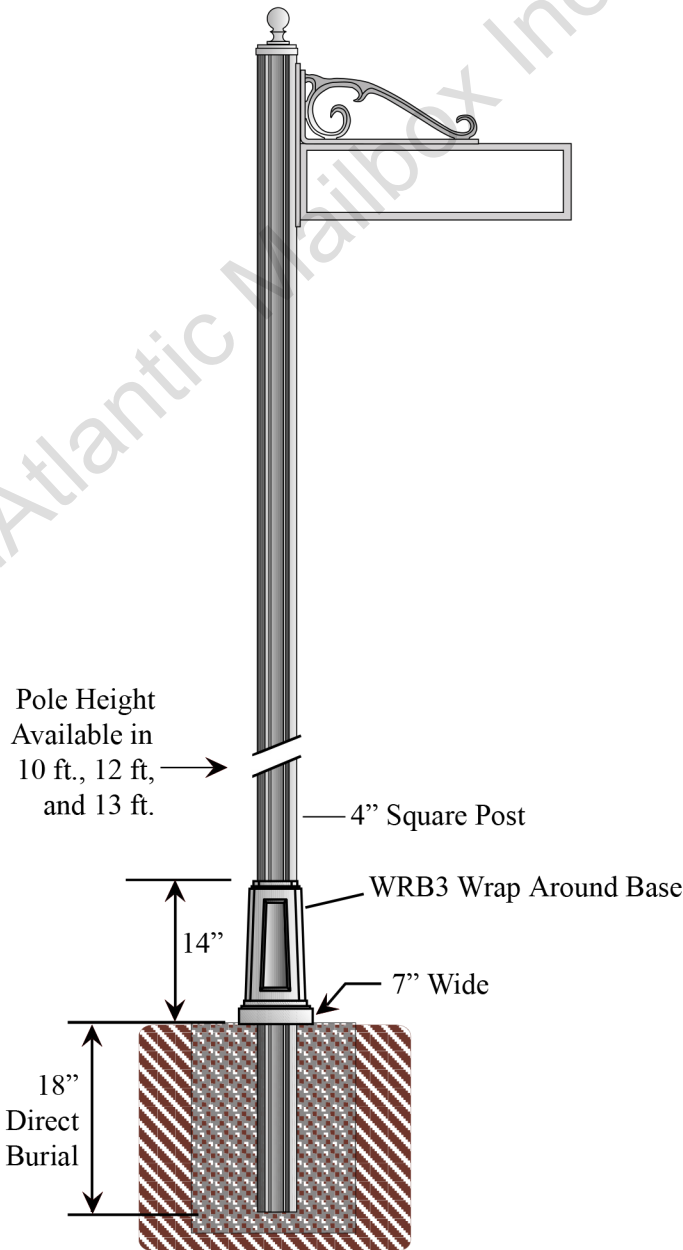

MP-7 Fluted Post**

- 4" Square Fluted Post
- Made of Extruded Aluminum
- .0188 Wall Thickness
- Direct Burial

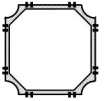

WRB3 - Decorative Wraparound Base

- Optional decorative base that fits over a 4" square post
- Made of Cast Aluminum

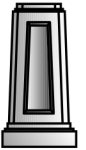

TSB-202 - Single Street Sign Mount

- Mounts to any square pole
- Can be ordered to hold any size sign blade
- Made of Extruded Aluminum
- (See Traffic Pole Accessories Section for product specifications)

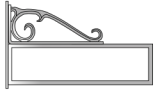

TSB11 - Post Topper

- Decorative Post Topper that fits 4" square posts.
- Made of Cast Aluminum.
- 4 1/4" wide x 5 1/4" tall



Additional Post Topper Options:



TSB12

Finish

- The fixture will be finished with a premium quality thermoset polyester powdercoat for a durable finish.

Installation Instructions for Direct Burial Posts:

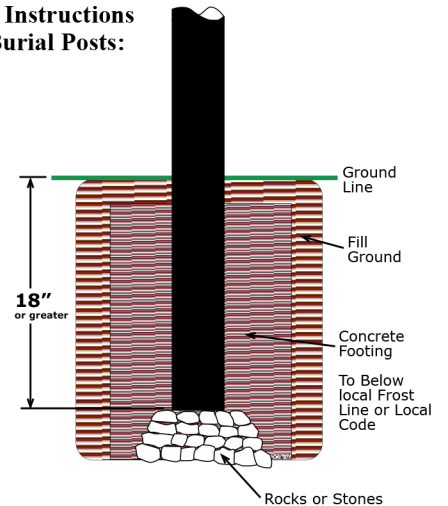

Poles available in the following heights:

10 ft. - 12 ft. - 13 ft.

(4" Square Pole with Street Sign Mount, Stop Sign Frame and Base)

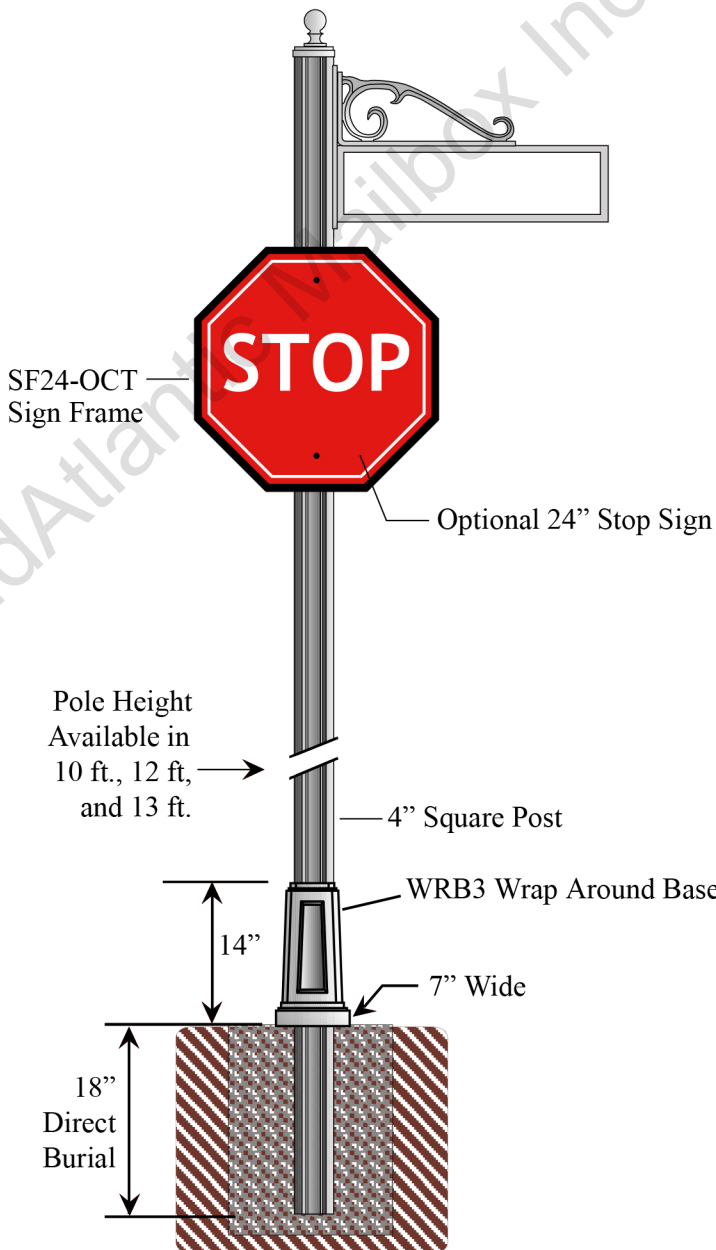

MP-7 Fluted Post**

- 4" Square Fluted Post
- Made of Extruded Aluminum
- .0188 Wall Thickness
- Direct Burial

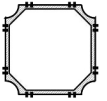

WRB3 - Decorative Wraparound Base

- Optional decorative base that fits over a 4" square post
- Made of Cast Aluminum

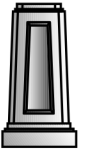

TSB-202 - Single Street Sign Mount

- Mounts to any square pole
 - Can be ordered to hold any size sign blade
 - Made of Extruded Aluminum
- (See Traffic Pole Accessories Section for product specifications)

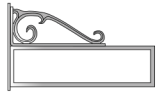

TSB11 - Post Topper

- Decorative Post Topper that fits 4" square posts.
- Made of Cast Aluminum.
- 4 1/4" wide x 5 1/4" tall



Additional Post Topper Options:



TSB12

SF24-OCT Sign Frame

- Fits around 24" Stop Sign
- Has a 1" square edge on all sides
- Made of Cast Aluminum

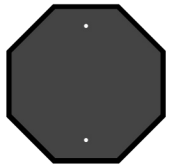

Finish

- The fixture will be finished with a premium quality thermoset polyester powdercoat for a durable finish.

Installation Instructions for Direct Burial Posts:

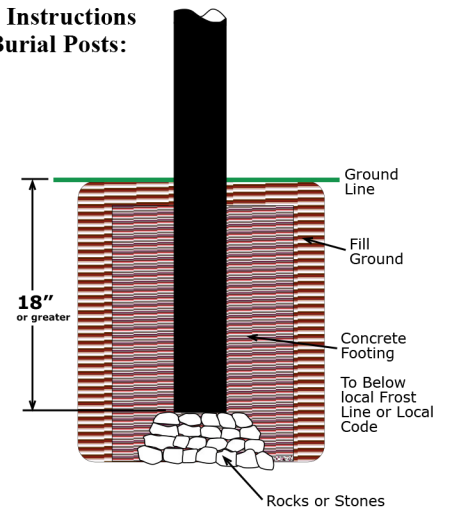

MidAtlantic Mailbox, Inc

Poles available in the following heights:
10 ft. - 12 ft. - 13 ft.

(4" Square Pole with Street Sign Mount and Base)

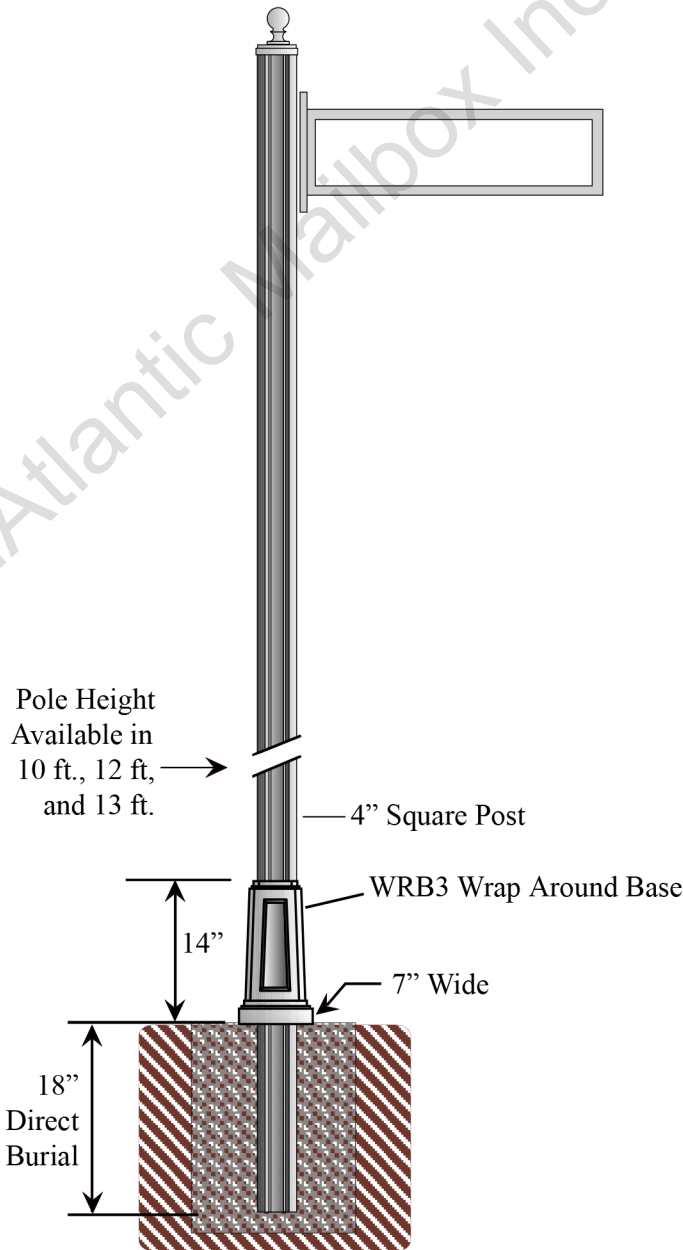

MP-7 Fluted Post**

- 4" Square Fluted Post
- Made of Extruded Aluminum
- .0188 Wall Thickness
- Direct Burial

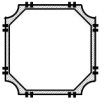

WRB3 - Decorative Wraparound Base

- Optional decorative base that fits over a 4" square post
- Made of Cast Aluminum

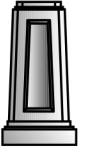

TSB-203 - Single Street Sign Mount

- Mounts to any square pole
 - Can be ordered to hold any size sign blade
 - Made of Extruded Aluminum
- (See Traffic Pole Accessories Section for product specifications)



TSB11 - Post Topper

- Decorative Post Topper that fits 4" square posts.
- Made of Cast Aluminum.
- 4 1/4" wide x 5 1/4" tall



Additional Post Topper Options:



TSB12

Finish

- The fixture will be finished with a premium quality thermoset polyester powdercoat for a durable finish.

Installation Instructions for Direct Burial Posts:

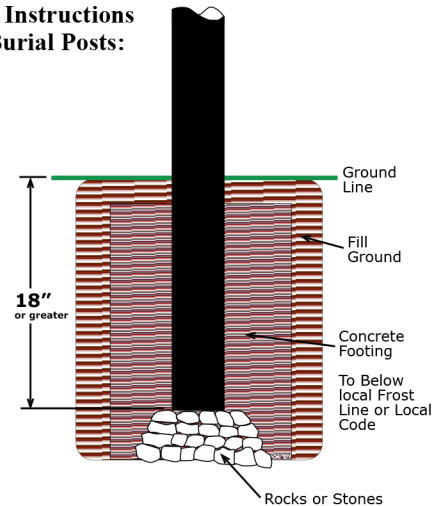

Poles available in the following heights:

10 ft. - 12 ft. - 13 ft.

(4" Square Pole with Street Sign Mount, Stop Sign Frame and Base)

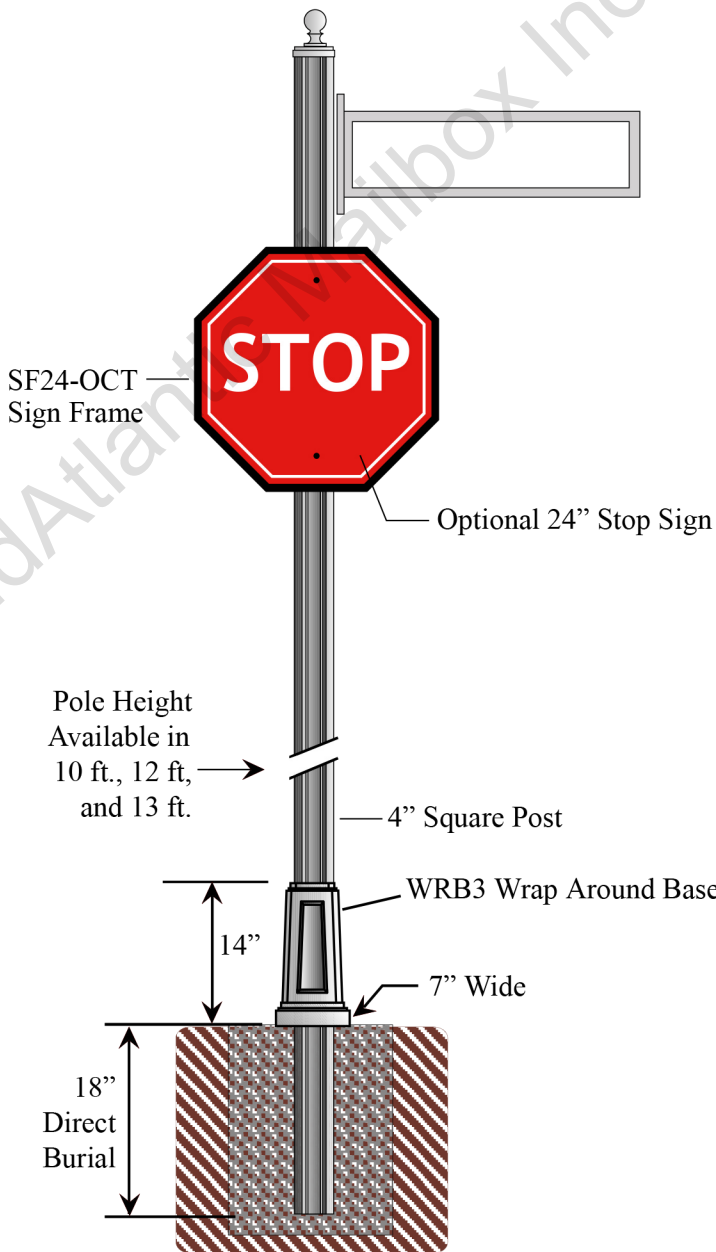

MP-7 Fluted Post**

- 4" Square Fluted Post
- Made of Extruded Aluminum
- .0188 Wall Thickness
- Direct Burial

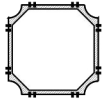

WRB3 - Decorative Wraparound Base

- Optional decorative base that fits over a 4" square post
- Made of Cast Aluminum

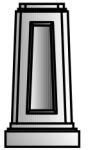

TSB-203 - Single Street Sign Mount

- Mounts to any square pole
 - Can be ordered to hold any size sign blade
 - Made of Extruded Aluminum
- (See Traffic Pole Accessories Section for product specifications)



TSB11 - Post Topper

- Decorative Post Topper that fits 4" square posts.
- Made of Cast Aluminum.
- 4 1/4" wide x 5 1/4" tall



Additional Post Topper Options:



TSB12

SF24-OCT Sign Frame

- Fits around 24" Stop Sign
- Has a 1" square edge on all sides
- Made of Cast Aluminum

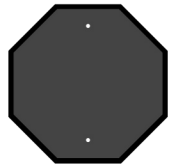

Finish

- The fixture will be finished with a premium quality thermoset polyester powdercoat for a durable finish.

Installation Instructions for Direct Burial Posts:

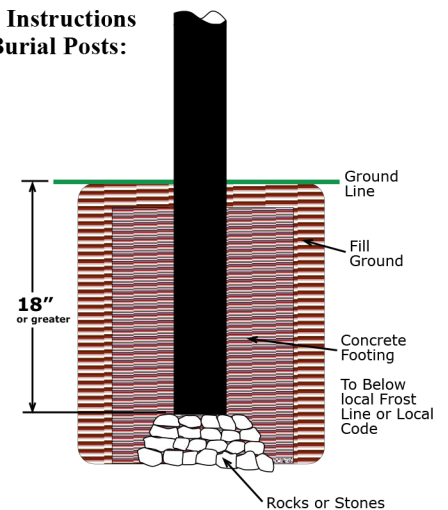

MidAtlantic Mailbox, Inc

Poles available in the following heights:
10 ft. - 12 ft. - 13 ft.

(4" Square Pole with Street Sign Mount and Base)

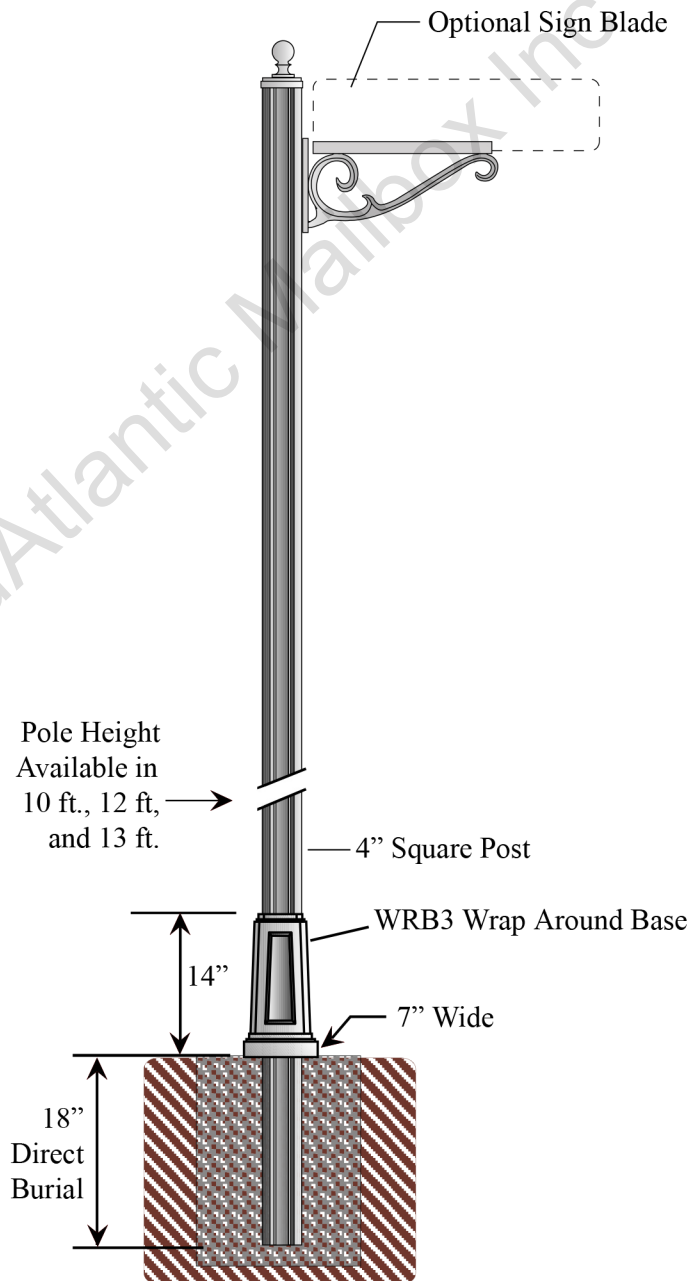

MP-7** Fluted Post

- 4" Square Fluted Post
- Made of Extruded Aluminum
- .0188 Wall Thickness
- Direct Burial

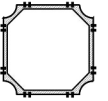

WRB3 - Decorative Wraparound Base

- Optional decorative base that fits over a 4" square post
- Made of Cast Aluminum



TSCR-700 - Single Street Sign Mount

- Mounts to any square pole
 - Can be ordered to hold any size sign blade
 - Made of Extruded Aluminum
- (See Traffic Pole Accessories Section for product specifications)

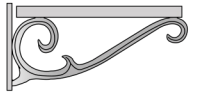

TSB11 - Post Topper

- Decorative Post Topper that fits 4" square posts.
- Made of Cast Aluminum.
- 4 1/4" wide x 5 1/4" tall



Additional Post Topper Options:



TSB12

Finish

- The fixture will be finished with a premium quality thermoset polyester powdercoat for a durable finish.

Installation Instructions for Direct Burial Posts:

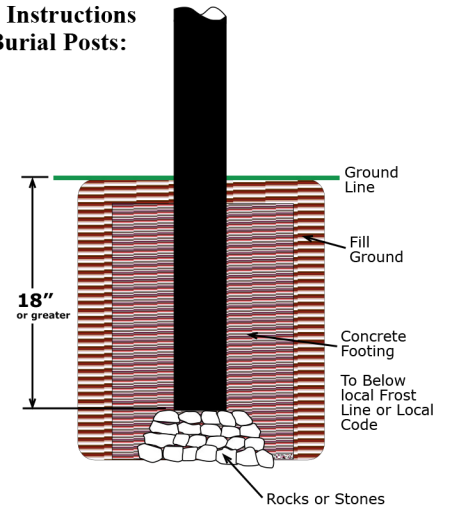

Poles available in the following heights:

10 ft. - 12 ft. - 13 ft.

(4" Square Pole with Street Sign Mount, Stop Sign Frame and Base)

MP-7 Fluted Post**

- 4" Square Fluted Post
- Made of Extruded Aluminum
- .0188 Wall Thickness
- Direct Burial

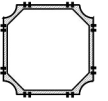

WRB3 - Decorative Wraparound Base

- Optional decorative base that fits over a 4" square post
- Made of Cast Aluminum



TSCR-700 - Single Street Sign Mount

- Mounts to any square pole
- Can be ordered to hold any size sign blade
- Made of Extruded Aluminum
- (See Traffic Pole Accessories Section for product specifications)

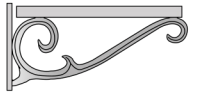

TSB11 - Post Topper

- Decorative Post Topper that fits 4" square posts.
- Made of Cast Aluminum.
- 4 1/4" wide x 5 1/4" tall



Additional Post Topper Options:



TSB12

SF24-OCT Sign Frame

- Fits around 24" Stop Sign
- Has a 1" square edge on all sides
- Made of Cast Aluminum

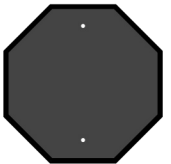

Finish

- The fixture will be finished with a premium quality thermoset polyester powdercoat for a durable finish.

Installation Instructions for Direct Burial Posts:

